

Brass Fittings, Nipples, Pipe & Flanges

INDEX

Threaded Brass Fittings / Raccords En Cuivre Filetes	
Standard 125lbs / Standard de 125 lbs	2
Extra Heavy 250lbs / Extra Pesant de 250 lbs	4
Threaded Brass Nipples / Mameons en cuivre filetes	5
Brass Hex Nipples / Mamelons en Cuivre Hex.	5
Brass Companion Flanges / Brides de compagnon en cuivre	
Standard Brass Threaded - 150# W.S.P.	6
Extra Heavy Brass Threaded - 300# W.S.P.	6
Standard Copper Solder - 150# W.S.P.	7
Standard Brass Blind - 150# W.S.P.	7
CTS Flange Adapter Kits	8
S.P.S. Red Brass Pipe	9
Mirror Finish Chrome Plated Brass Pipe.....	9
S.P.S. Copper Pipe	10
Large Size Copper Water Tube	10
Brass Bra-Zon-Tees.....	11
Di-Electric Unions	12
Brass Hose Fittings	13
Brass Insert Fittings and Tank Tees	14, 15

Threaded Brass Fittings / Raccords En Cuivre Filetes

Standard 125LBS. / Standard De 125 LBS.

Part No. SB	Description	02 04 1/8" 1/4"	06 3/8"	08 1/2"	12 3/4"	16 1"	20 1 1/4"	24 1 1/2"
235	90° Elbows - Coudes 90°	21.80	21.80	23.55	31.15	50.15	81.00	100.45
235	Reducing - Reducteurs	34.15	34.15	36.90	50.25	87.65	138.05	170.00
254	Street - MxF	28.80	28.80	31.15	42.50	69.65	127.20	138.75
240	Drop - De Fixation	POA	POA	POA				
290	45° Elbows - Coudes 45°	23.70	23.70	25.65	38.75	65.70	104.35	131.10
295	Street MxF	32.30	32.30	34.85	50.10	84.90	131.10	194.85
460	Tees - Tes	25.15	25.15	27.20	38.75	69.65	119.55	134.90
460	Reducing Tees - Tes Reducteurs							
	1 opening - ouverture	42.60	42.60	46.05	46.40	128.65	183.80	247.55
	2 openings - ouverture			129.55	143.90	153.60	215.70	700.25
195	Crosses - Croix	47.75	47.75	63.85	90.95	146.05	247.35	327.60
155	Caps - Capuchons	14.40	14.40	15.85	20.60	35.05	61.70	81.00
165	Couplings - Manchons	18.00	18.00	19.45	27.20	46.40	77.10	100.45
165	Reducing Couplings - Manchons Reducteurs							
	1-2 sizes - dimensions	21.35	21.35	23.10	31.05	51.35	100.45	127.00
	Over 2 sizes - Plus que 2 dimensions			31.05	42.50	69.60	111.80	138.80
657	Unions	57.00	57.00	61.55	84.90	111.80	161.95	192.80
415	Closed Return Bend			83.70		170.55		
418	Open Return Bend			100.70		204.55	240.65	
396	Plugs Square Head - Bouchons Tête Carrée							
	Cored - Evidé	18.00	18.00	16.20	19.45	31.05	42.15	54.30
399	Solid - Plein	18.00	18.00	19.45	25.65	48.95	107.85	114.05
397	Plugs Countersunk -Tête Fraisée	21.90	21.90	23.65	35.00	58.80	136.45	143.55
398	Plugs Hex Head - Tête Hex	19.15	19.15	24.75	27.35			
375	Locknuts - Contre Ecrous	14.35	14.35	15.50	19.45	27.15	47.05	61.05
140	Face Bushings - Reducteurs MxF	27.80	27.80	43.95	61.75	POA	POA	POA
144	Hexagon Bushings - Reducteurs							
	Red. 1-2 sizes dimensions	14.35	14.35	15.50	19.45	27.15	46.45	65.70
	Red. over 2 sizes - plus 2 dimen.			19.45	27.15	38.85	65.75	84.90
	Red. over 3 sizes - plus 3 dimen.				28.25	40.35	68.45	88.35
840	Y Laterals - Uen Branches	POA	POA	POA	POA	POA	POA	POA
355	Floor Flanges - Brides	POA	POA	67.50	92.05	150.25	171.75	264.00
358	Tank Flanges	POA	59.60	POA	85.80	POA	183.00	255.90
335	Extension Pieces - Pieces d'Extension	POA	23.45	54.55	POA	POA	POA	POA

For 3/8" & 1/2" Chrome Plated, add (x4) – all other sizes, add (x6) Pour 3/8" & 1/2" Chromé, ajouter (x4), toutes autre grandeurs, ajouter (x6)
 For Polished Brass, add (x7) Pour Laiton Poli, ajouter (x7)

Fittings with Canadian Registration numbers maybe subject to a higher price.

Threaded Brass Fittings / Raccords En Cuivre Filetes

Standard 125 LBS. Standard De 125 LBS.

Part No. SB	Description	32 2"	40 2 1/2"	48 3"	64 4"	80 5"	96 6"
235	90° Elbows - Coudes 90°	161.95	430.20	790.20	1603.75	POA	POA
235	Reducing - Reducteurs	302.75	620.15	POA	POA		
254	Street - MxF	235.25	490.15	1013.65	POA		
290	45° Elbows - Coudes 45°	212.90	466.80	863.60	1930.50		
295	Street MxF	304.25					
460	Tees - Tes	223.45	581.00	1076.95	2674.20		
460	Reducing Tees - Tes Reducteurs						
	1 opening - ouverture	414.20	1076.95	1970.60	POA		
	2 openings - ouverture	1076.15	POA	POA	POA		
195	Crosses - Croix	671.65	POA	POA	POA		
155	Caps - Capuchons	138.65	294.30	543.50	POA		POA
165	Couplings - Manchons	165.75	312.00	516.90	1067.00	POA	4709.60
165	Reducing Couplings - Manchons Reducteurs						
	1-2 sizes - dimensions	196.85	383.45	673.70	1640.35		
	Over 2 sizes - plus que 2 dimensions	208.10	430.20	POA	POA		
657	Unions	296.70	883.70	1640.45	3654.30		
396	Plugs Square Head - Bouchons Tête Carrée						
	Cored - Evidé	88.70	174.00	330.25	620.30		
399	Solid - Plein	173.55	POA	595.95	POA		
397	Plugs Countersunk - Tete Fraisée	POA	POA	POA	POA		
375	Locknuts - Contre Ecrous	84.90	POA	383.10	POA		
140	Face Bushings - Reducteurs MxF	POA					
144	Hexagon Bushings - Reducteurs						
	Red. 1-2 sizes - dimensions	83.00	236.60	416.90	913.70		
	Red. over 2 sizes - plus de 2 dimen.	123.50	285.60	500.15	1253.65		
	Red. over 3 sizes - plus de 3 dims.	128.45	297.50	521.70	1308.35		
840	Y Laterals - Yen Branches	3106.70	POA	POA			
355	Floor Flanges - Brides	351.35					
358	Tank Flanges	344.10					
335	Extension Pieces - Pieces d'Extension	POA					

For Chrome Plated, add (x6)

For Polished Brass, add (x7)

Pour Chromé pour ajouter (x6)

Pour Laiton Poli, ajouter (x7)

Threaded Brass Fittings / Raccords En Cuivre Filetes

Extra Heavy 250 LBS. / Extra Pesant De 250 LBS.

Part No. EB	Description	04 06 1/4", 3/8"	08 1/2"	12 3/4"	16 1"	20 1 1/4"	24 1 1/2"	32 2"	40 2 1/2"	48 3"
235	90° Elbows2 Coudes 90°	51.35	77.10	104.10	154.70	277.35	411.80	685.75	1117.45	1612.45
254	90° Street Elbows Coudes 90° MxF	146.90	146.90	314.10	368.10	461.85	717.15	825.00		
290	45° Elbows - Coudes 45°		66.15	109.65	192.15	290.85	715.15			
460	Tees - Tes	82.55	92.90	151.25	206.35	387.45	548.70	797.10	1396.70	1853.75
165	Couplings - Manchon	64.95	77.55	114.55	173.90	251.45	318.90	507.65	701.60	1013.75
657	Unions - Unions	123.80	123.80	175.40	237.35	330.15	433.15	684.35	1106.25	1893.65
155	Caps - Capuchons	54.35	90.85	114.45	173.75	249.25	309.15	507.35	701.60	1237.15
195	Crosses - Croix	72.65	150.45	231.05	362.55	512.45	795.30	1279.85		
668	Union Elbows FxF Coudes Union FxF	288.95	330.30	450.25	758.75	1084.35	1343.00	2051.40		

Cast Bronze Threaded Fittings (125lb) (250lb)

Standard Specifications

Materials: ASTM B 584-93b Copper Alloy UNS. No. 83800

Dimensions: ANSI B 16.15

Threads: ANSI B2.1 OR BS 21

Imperial to Metric Conversions (Nominal)

INCH	mm
1/8	4
1/4	8
3/8	10
1/2	15
3/4	20

INCH	mm
1	25
1 1/4	32
1 1/2	40
2	50
2 1/2	65

INCH	mm
3	80
4	100
5	125
6	150
8	200

Threaded Brass Nipples / Mamelons en Cuivre Filetes

BN	Pipe Size	Length of Close	000 CLOSE	015 1 1/2"	020 2"	025 2 1/2"	030 3"	035 3 1/2"	040 4"	045 4 1/2"	050 5"	055 5 1/2"	060 6"
02	1/8"	3/4"	10.45	12.00	13.15	14.95	16.15	17.65	19.35	20.75	22.20	23.85	25.65
04	1/4"	7/8"	12.00	13.65	15.50	17.65	19.50	22.20	24.75	27.90	30.15	32.30	34.75
06	3/8"	1"	13.10	14.55	17.40	20.60	23.15	27.25	30.15	33.85	36.95	39.80	42.95
08	1/2"	1 1/8"	15.50	18.25	22.20	26.35	30.35	36.00	40.45	44.40	48.55	53.15	57.20
12	3/4"	1 3/8"	22.65	23.85	28.85	33.85	38.45	44.10	49.80	52.55	60.65	67.75	73.75
16	1"	1 1/2"	34.70		41.40	49.10	55.50	65.55	73.25	80.95	87.95	97.20	105.00
20	1 1/4"	1 5/8"	51.05		58.20	70.10	81.90	96.00	107.85	119.70	131.45	143.65	155.45
24	1 1/2"	1 3/4"	63.35		68.75	83.45	94.70	111.25	125.25	139.70	153.75	167.35	181.10
32	2"	2"	97.20			107.30	122.25	143.00	160.80	178.20	194.30	214.20	231.90
40	2 1/2"	2 1/2"	259.70				275.90	316.35	349.05	369.30	401.45	489.95	464.95
48	3"	2 5/8"	366.05				382.75	437.35	486.45	534.60	582.75	631.05	679.25
64	4"	2 7/8"	543.45				556.65	648.50	718.65	793.15	867.65	937.80	1012.35
80	5"	3"					Price on application / Prix sur demande						
96	6"	3 1/8"					Price on application / Prix sur demande						

KN For Chrome Plated Nipples / Mamelons Chromes - add/ajouter for 3/8" and 1/2" (x3), all other sizes (x5)

EN For Extra Heavy Nipples (Sch. 80) Mamelons Extra-Pesant (Sch.80) add/ajouter (x3)

PN For Polished Brass Nipples / Mamelons Laiton Poli - add/ajouter (x2.5)

CN For Copper Nipples / Mamelons en Cuivre - add/ajouter (x2.5)

EC For Extra Heavy Copper Nipples / Mamelons Extra-Pesant en Cuivre-add/ajouter (x4)

All other lengths - Price on Application / Tous les autres longuers - Prix sur demande

Aluminum Nipples - Price on Application / Mamelons en Aluminium - Prix sur Demande

Nipple Weight Chart

Approximate Weight per 100 pieces. Standard Brass Nipples

Dia.	Length of Close	Close	1 1/2"	2"	2 1/2"	3"	3 1/2"	4"	4 1/2"	5"	5 1/2"	6"
1/8"	3/4"	2#	3#	3#	4#	6#	7#	8#	9#	10#	11#	12#
1/4"	7/8"	3#	5#	7#	8#	10#	11#	14#	15#	16#	18#	21#
3/8"	1"	4#	7#	9#	11#	13#	15#	18#	20#	21#	25#	28#
1/2"	1 1/8"	8#	10#	13#	16#	19#	23#	27#	31#	34#	38#	45#
3/4"	1 3/8"	10#	15#	18#	22#	26#	30#	37#	41#	45#	50#	58#
1"	1 1/2"	20#		27#	33#	39#	45#	55#	62#	68#	74#	86#
1 1/4"	1 5/8"	30#		37#	45#	52#	61#	73#	83#	91#	101#	118#
1 1/2"	1 3/4"	37#		45#	53#	63#	72#	88#	99#	110#	120#	140#
2"	2"	58#			71#	84#	97#	119#	132#	147#	160#	190#
2 1/2"	2 1/2"	90#				110#	140#	165#	190#	210#	230#	260#
3"	2 5/8"	140#				160#	195#	230#	270#	310#	345#	380#
3 1/2"	2 3/4"	192#				210#	253#	316#	350#	382#	448#	469#
4"	2 7/8"	220#				240#	290#	362#	400#	437#	512#	537#

Brass Hex. Nipples / Mamelons en Cuivre Hex.

	02 1/8"	04 1/4"	06 3/8"	08 1/2"	12 3/4"	16 1"
HN	2.55	4.15	6.20	11.05	26.55	60.20

Brass Companion Flanges / Brides De Compagnon En Cuivre Standard Brass Threaded - 150# W.S.P.

SB 342	Nom. Pipe Size	List Price Each	Wgt. Per 100	Flange O.D.	Bolt Circle Dia.	Height	Flange Thick-ness	Bolt Size	No. of Bolt Holes
08	1/2"	306.80	95	3 1/2"	2 3/8"	1 9/32"	5/16"	5/8"	4
12	3/4"	319.10	124	3 7/8"	2 3/4"	5/8"	1 1/32"	5/8"	4
16	1"	365.10	168	4 1/4"	3 1/8"	1 1/16"	3/8"	5/8"	4
20	1 1/4"	426.45	224	4 5/8"	3 1/2"	1 3/16"	1 3/32"	5/8"	4
24	1 1/2"	527.60	289	5"	3 7/8"	7/8"	7/16"	5/8"	4
32	2"	662.65	422	6"	4 3/4"	1"	1/2"	3/4"	4
40	2 1/2"	1073.65	653	7"	5 1/2"	1 1/8"	9/16"	3/4"	4
48	3"	1592.00	772	7 1/2"	6"	1 3/16"	5/8"	3/4"	4
56	3 1/2"	P.O.A.	Prices on application - Prix sur Demande						
64	4"	2277.75	1227	9"	7 1/2"	1 5/16"	1 1/16"	3/4"	8
80	5"	3385.65	1495	10"	8 1/2"	1 7/16"	3/4"	7/8"	8
96	6"	3555.05	1801	11"	9 1/2"	1 9/16"	1 3/16"	7/8"	8
97	8"	P.O.A.	Prices on application - Prix sur Demande						

Dimensions conform to ASA B16.24-1962

Chemical and Physical Properties to ATSM B62

Brass Companion Flanges / Brides De Compagnon En Cuivre Extra Heavy Brass Threaded - 300# W.S.P.

EB 345	Nom. Pipe Size	List Price Each	Wgt. Per 100	Flange O.D.	Bolt Circle Dia.	Height	Flange Thick-ness	Bolt Size	No. of Bolt Holes
12	3/4"	P.O.A.	300	4 5/8"	3 1/4"	5/8"	1 7/32"	3/4"	4
16	1"	1005.65	303	4 7/8"	3 1/2"	1 1/16"	1 9/32"	3/4"	4
20	1 1/4"	P.O.A.	400	5 1/4"	3 7/8"	1 3/16"	5/8"	3/4"	4
24	1 1/2"	1420.35	575	6 1/8"	4 1/2"	7/8"	1 1/16"	7/8"	4
32	2"	1882.70	645	6 1/2"	5"	1"	3/4"	3/4"	8
40	2 1/2"	2428.45	915	7 1/2"	5 7/8"	1 1/8"	1 3/16"	7/8"	8
48	3"	2987.90	1100	8 1/4"	6 5/8"	1 3/16"	2 9/32"	7/8"	8
56	3 1/2"	P.O.A.	Prices on application - Prix sur Demande						
64	4"	5007.00	1850	10"	7 7/8"	1 5/16"	1 1/16"	7/8"	8
80	5"	P.O.A.	2425	11"	9 1/4"	1 7/16"	1 1/8"	7/8"	8
96	6"	P.O.A.	3425	12 1/2"	10 5/8"	1 9/16"	1 3/16"	7/8"	12
97	8"	P.O.A.	Prices on application - Prix sur Demande						

Dimensions conform to ASA B16.24-1962

Chemical and Physical Properties to ATSM B62

Brass Companion Flanges / Brides De Compagnon En Cuivre Standard Copper Solder - 125# W.S.P.

SP-PC 342	Nom. Pipe Size	Tube O.D.	List. Price Each	Wgt. Per 100	Flange O.D.	Bolt Circle Dia.	Flange Thick-ness	Bolt Hole Diam.	No. of Bolt Holes
08	1/2"	.625	240.00	70	3 1/2"	2 3/8"	5/16"	5/8"	4
12	3/4"	.875	348.00	105	3 7/8"	2 3/4"	11/32"	5/8"	4
16	1"	1.120	370.00	123	4 1/4"	3 1/8"	3/8"	5/8"	4
20	1 1/4"	1.375	424.00	160	4 5/8"	3 1/2"	13/32"	5/8"	4
24	1 1/2"	1.625	681.00	189	5"	3 7/8"	7/16"	5/8"	4
32	2"	2.125	854.00	337	6"	4 3/4"	1/2"	3/4"	4
40	2 1/2"	2.625	1110.00	497	7"	5 1/2"	9/16"	3/4"	4
48	3"	3.125	1110.00	617	7 1/2"	6"	5/8"	3/4"	4
64	4"	4.125	1657.00	800	9"	7 1/2"	11/16"	3/4"	8
80	5"	5.125	3233.00	1264	10"	8 1/2"	3/4"	7/8"	8
96	6"	6.125	3533.00	1426	11"	9 1/2"	13/16"	7/8"	8
97	8"	8.125	8485.00	2500	13 1/2"	11 3/4"	15/16"	7/8"	8

Dimensions conform to ASA B16.24-1962

Chemical and Physical Properties to ATSM B62

Brass Companion Flanges / Brides De Compagnon En Cuivre Standard Copper Solder - 150# W.S.P.

PC 342	Nom. Pipe Size	List. Price Each	Wgt. Per 100	Flange O.D.	Bolt Circle Dia.	Flange Thick-ness	Bolt Hole Diam.	No. of Bolt Holes
08	1/2"	431.00	88	3 1/2"	2 3/8"	5/16"	5/8"	4
12	3/4"	429.00	115	3 7/8"	2 3/4"	11/32"	5/8"	4
16	1"	550.00	160	4 1/4"	3 1/8"	3/8"	5/8"	4
20	1 1/4"	699.00	195	4 5/8"	3 1/2"	13/32"	5/8"	4
24	1 1/2"	840.00	225	5"	3 7/8"	7/16"	5/8"	4
32	2"	1505.00	422	6"	4 3/4"	1/2"	3/4"	4
40	2 1/2"	1848.00	625	7"	5 1/2"	9/16"	3/4"	4
48	3"	1848.00	788	7 1/2"	6"	5/8"	3/4"	4
56	3 1/2"	4166.00	1070	8 1/2"	7"	5/8"	3/4"	8
64	4"	2869.00	1200	9"	7 1/2"	11/16"	3/4"	8
80	5"	6260.00	1695	10"	8 1/2"	3/4"	7/8"	8
96	6"	6130.00	2090	11"	9 1/2"	13/16"	7/8"	8
97	8"	13337.00	3750	13 1/2"	11 3/4"	15/16"	7/8"	8

Dimensions conform to ASA B16.24-1962

Chemical and Physical Properties to ATSM B62

Brass Blind Companion Flanges available upon request.

CTS Copper Tube Flanges (with Adapters and Kits)

	1 1/2"	2"	2 1/2"	3"	4"	5"	6"	8"
Basic CTS Flange Adapter (Insulated coated steel flange plus copper adapter)	147.95	167.55	211.40	265.35	336.65	485.95	553.80	864.35
CTS Flange Adapter Kit (Also includes nuts, bolts and ring gaskets)	175.00	183.80	219.50	278.05	365.95	510.25	642.25	923.90
CTS Rolled Grooved Kit (Also includes nuts, bolts and ring gaskets)	N/A	146.65	173.70	188.50	245.00	297.70	322.50	372.10
Other CTS Products Includes 300lb flanges, Reducing Flanges, Rolled Grooved Kits, Extended Flanges and 300lb Extended Flanges & Basic Black Steel Roll Grooved Flanges	P.O.A.							

- Huge savings in Gas and Solder
- Easy alignment to existing piping
- Installation time savings of up to 80%
- Flange has a Fusion Bonded Polyester Coating
- Registered Design - UL Classified to ASME B16.22-95
- 100% Electrolysis Protection - No Bolt Insulators required

3 Easy Steps to Install:

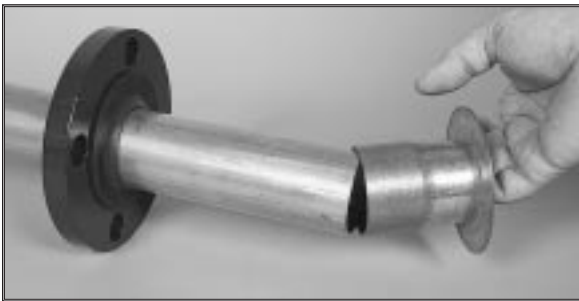

1. Slide flange over pipe and attach CTS Flange Adapter



2. Braze or solder the CTS Adapter



3. Slide the flange back over adapter, align bolt holes, and tighten

S.P.S. Red Brass Pipe
Standard Sch. 40 - BP
Extra Heavy Sch. 80 - EP

	Pipe Size	O.D. Inches	Wall Inches	Weight Per 12' Length	Sch. 40 (BP) Price Per Foot	Wall Inches	Weight Per 12' Length	Sch. 80 (EP) Price Per Foot
02	1/8"	.405	.062	3.03	11.75	.100	4.35	29.35
04	1/4"	.540	.082	5.40	19.75	.123	7.33	40.75
06	3/8"	.675	.090	7.56	25.35	.127	9.94	51.40
08	1/2"	.840	.107	11.25	34.85	.149	14.76	70.75
12	3/4"	1.050	.114	15.24	46.60	.157	20.04	92.00
16	1"	1.315	.126	21.48	64.50	.182	29.52	130.70
20	1 1/4"	1.660	.146	31.56	97.05	.194	40.68	183.10
24	1 1/2"	1.900	.150	37.56	116.05	.203	49.20	219.95
32	2"	2.375	.156	49.68	152.60	.221	68.04	296.50
40	2 1/2"	2.875	.187	72.00	224.60	.280	103.92	452.70
48	3"	3.500	.219	102.72	319.40	.304	138.92	619.40
56	3 1/2"	4.000	.250	134.04	P.O.A.	.321	168.84	P.O.A.
64	4"	4.500	.250	151.92	553.70	.341	202.68	1147.15
80	5"	5.563	.250	190.20	P.O.A.	.375	278.16	P.O.A.
96	6"	6.625	.250	228.00	P.O.A.	.437	386.62	P.O.A.
97	8"	8.625	.312	371.40	P.O.A.	.500	580.80	P.O.A.

For Cut Lengths over 24", add 30%.

Threading Charges - 1/8" to 1", add 30%. Over 1", add 20%.

Mirror Finish Chrome Plated Brass - KP
6' Lengths - Plain Ends

	06	08	12	16	20	24	32
Size	3/8"	1/2"	3/4"	1"	1 1/4"	1 1/2"	2"
Price	409.70	562.95	752.05	1040.95	1451.90	1874.15	2174.25

For longer lengths in Chrome Plated Brass - Price on Application.
 For Polished or Lacquered Brass - Price on Application.

Pour longueurs plus longues en Laiton Chromé - Prix Sure Demande.
 Pour Laiton Poli ou Batture - Prix Sur Demande.

S.P.S. Copper Pipe
Standard Sch. 40 - CP
Extra Heavy Sch. 80 - EC

	Pipe Size	O.D. Inches	Wall Inches	Weight Per 12' Length	Sch. 40 (CP) Price Per Foot	Wall Inches	Weight Per 12' Length	Sch. 80 (EC) Price Per Foot
02	1/8"	.405	.062	3.10	P.O.A	.100	4.45	P.O.A
04	1/4"	.540	.082	5.52	P.O.A	.123	7.50	P.O.A
06	3/8"	.675	.090	7.71	P.O.A	.127	10.15	P.O.A
08	1/2"	.840	.107	11.48	P.O.A	.149	15.00	P.O.A
12	3/4"	1.050	.114	15.60	P.O.A	.157	20.50	P.O.A
16	1"	1.315	.126	21.96	P.O.A	.182	30.10	P.O.A
20	1 1/4"	1.660	.146	32.28	P.O.A	.194	41.50	P.O.A
24	1 1/2"	1.900	.150	38.40	P.O.A	.203	50.30	P.O.A
32	2"	2.375	.156	50.76	P.O.A	.221	69.60	P.O.A
40	2 1/2"	2.875	.187	73.68	P.O.A	.280	106.20	P.O.A
48	3"	3.500	.219	105.00	P.O.A	.304	141.60	P.O.A
56	3 1/2"	4.000	.250	136.92	P.O.A	.321	172.80	P.O.A
64	4"	4.500	.250	155.28	P.O.A	.341	207.60	P.O.A
80	5"	5.563	.250	194.52	P.O.A	.375	284.40	P.O.A
96	6"	6.625	.250	232.92	P.O.A	.437	394.80	P.O.A
97	8"	8.625	.312	379.56	P.O.A	.500	594.00	P.O.A

For Cut Lengths over 24", add 30%.

Threading Charges - 1/8" to 1", add 30%. Over 1, add 20%.

Brass, Copper & Stainless Steel Tubes, Sheets & Rods available - Price on Application.

Laiton, Cuivre & Acier Inoxydable Tubes, Feuilles & Barres Disponible - Prix on Demande.

NOTE: Prices for Sch. 80 Extra Heavy Copper Pipe subject to material availability.

Copper Water Tube - Large Sizes

	WT	80 5" 20 Foot Lengths	Price Per Foot	96 6" 20 Foot Lengths	Price Per Foot	97 8" 20 Foot Lengths	Price Per Foot
K	O.D.	5.125		6.125		8.125	
	Wall	.160	P.O.A.	.192	P.O.A.	.271	P.O.A.
	Lbs/Foot	9.67 Lbs		14 Lbs		26 Lbs	
L	O.D.	5.125		6.125		8.125	
	Wall	.125	P.O.A.	.140	P.O.A.	.200	P.O.A.
	Lbs/Foot	7.61 Lbs		10.25 Lbs		19.5 Lbs	
M	O.D.	5.125		6.125		8.125	
	Wall	.109	P.O.A.	.122	P.O.A.	.170	P.O.A.
	Lbs/Foot	6.67 Lbs		8.92 Lbs		16.5 Lbs	
DWV	O.D.	5.125		6.125		8.125	
	Wall	.072	P.O.A.	.083	P.O.A.	.109	P.O.A.
	Lbs/Foot	4.45 Lbs		6 Lbs		11 Lbs	

F.O.B Toronto

Inquiries over 2,000 lbs. P.O.A.

Brass Bra-Zon-Tees

Pipe Run Size	1/2"	3/4"	1"	1 1/4"	1 1/2"	2"	2 1/2"	3"	3 1/2"	4"
1"	33.15									
1 1/4"	33.15	34.15								
1 1/2"			39.50							
2"				58.40						
2 1/2"			55.50	79.00	85.65					
3"			62.50	86.25	92.50					
3 1/2"										
4"							158.50	227.50		
5"										
6"	95.75									

Price subject to existing stock.
Sizes not shown are P.O.A. Thread-O-Lets & Braz-O-Lets also available.

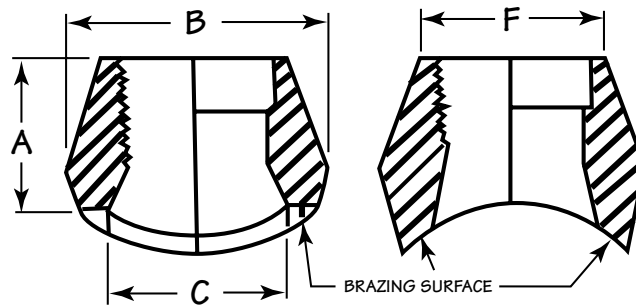

Bra-zon-Tees for Pipe

Outlet Sizes	A	B	C	Brazing Surface	F-Min
1/4	11/16	1	9/16	.188	.700
3/8	3/16	1 1/4	3/4	.190	.855
1/2	1	1 7/16	7/8	.220	1.020
3/4	1 1/16	1 3/4	1 1/8	.240	1.250
1	1 1/4	2 1/8	1 7/16	.270	1.535
1 1/4	1 3/16	2 9/16	1 3/4	.300	1.900
1 1/2	1 3/8	2 7/8	2	.330	2.160
2	1 1/2	3 1/2	2 9/16	.360	2.675
2 1/2	1 13/16	4 1/8	3	.384	3.215
3	2	4 13/16	3 1/16	.442	3.880
4	2 1/4	6	4 3/4	.476	4.940
5	2 3/4	7 1/16	5 9/16	.636	6.163

**Bra-Zon-Tees for Tubing
Type K,L and M Tubing**

Outlet Sizes	A	B	C	Brazing Surface	F-Min
1/4 & 3/8	1 1/16	1	9/16	.188	.700
1/2	1 3/16	1 1/4	3/4	.190	.855
3/4	1	1 7/16	7/8	.220	1.020
1	1 1/16	1 3/4	1 1/8	.240	1.250
1 1/4	1 1/4	2 1/8	1 7/16	.270	1.535
1 1/2	1 3/16	2 9/16	1 3/4	.300	1.900
2	1 3/8	2 7/8	2	.330	2.160
2 1/2	1 1/2	3 1/2	2 9/16	.360	2.675
3	1 13/16	4 1/8	3	.384	3.215
4	2 1/8	5 1/2	4 5/16	.437	4.400

NOTE: Capitol Manufacturing no longer manufactures. We will supply until stock is depleted.

Capitol Di-Electric Unions

Copper From Steel (F.I.P.)			Brass From Steel (F.I.P.)		
CA CS-22	1/2"	21.65	CA SB-22	1/2"	37.55
CA CS-32	1/2" x 3/4"	21.65	CA SB-33	3/4"	52.20
CA CS-33	3/4"	21.65	CA SB-44	1"	84.25
CA CS-43	3/4" x 1"	53.80	CA SB-55	1 1/4"	112.15
CA CS-44	1"	49.10	CA SB-66	1 1/2"	174.30
CA CS-55	1 1/4"	116.70	CA SB-77	2"	217.90
CA CS-66	1 1/2"	116.70	Steel From Steel (F.I.P.) - Gas Service		
CA CS-77	2"	144.60	CA GS-22	1/2"	32.15
Steel From Steel (F.I.P.)			CA GS-44	1"	50.20
CA SS-22	1/2"	32.20	CA GS-66	1 1/2"	152.75
CA SS-32	1/2" x 3/4"	40.90	Di-Electric Flanged Unions (Copper From Steel)		
CA SS-33	3/4"	40.90	CA F-8	2 1/2"	404.94
CA SS-44	1"	86.35	CAF-9	3"	512.89
CA SS-55	1 1/4"	112.90	CA F-10	4"	809.89
CA SS-66	1 1/2"	183.40	Di-Electric Flanged Unions (Steel From Steel)		
CA SS-77	2"	209.65	CA T-10	4"	1076.15

Capitol Insulating Union Parts

Buna-N-Gasket For Use With					
CS 22 32 33	SS 22 32	SB 22 32 33	CMS 22 32 33	CA-G-1	1.30
SS-33, SB-33				CA-G-2	2.85
CS-43, CS-44				CA-G-.3	3.60
CS-55				CA-G-4	4.35
SS-44, SB-44				CA-G-5	4.70
CS-66, SS-55, SB-55				CA-G-6	5.85
CS-77				CA-G-7	6.85
SS-66, SB-66				CA-G-8	7.80
SS-77, SB-77				CA-G-9	10.25
5/8" Bolt Insulators				SA-CA-999	20.95

Other Parts - Price on Application

Import Di-Electric Unions

Copper From Steel (F.I.P.)		
IM-CS-22	1/2"	11.70
IM-CS-32	1/2" x 3/4"	12.80
IM-CS-33	3/4"	12.80
IM-CS-44	1"	31.90
IM-CS-55	1 1/4"	35.65
IM-CS-66	1 1/2"	57.30
IM-CS-77	2"	76.10
Steel From Steel (F.I.P.)		
IM-SS-22	1/2"	15.85
IM-SS-32	1/2" x 3/4"	17.30
IM-SS-33	3/4"	17.30
IM-SS-44	1"	41.50
IM-SS-55	1 1/4"	46.30
IM-SS-66	1 1/2"	74.45
IM-SS-77	2"	98.90

Brass Hose Fittings

Connector - Hose Barb - Male Hose Thread		
HF193-06	3/8"	7.95
HF193-08	1/2"	7.45
HF193-10	5/8"	7.70
HF193-12	3/4"	7.95
HF193-16	1"	18.15
Coupling - Male Hose to Male Pipe		
HF196-06	3/4" x 3/8"	8.80
HF196-08	3/4" x 1/2"	5.75
HF196-12	3/4" x 3/4"	5.95
HF196-1216	3/4" x 1"	25.55
HF196-16	1" x 1"	25.55
HF196-24	1 1/2" x 1 1/2"	107.50
Coupling - Female Hose to Female Pipe		
HF198-08	1/2"	8.25
HF198-12	3/4"	7.95
Cap Nut		
Stock No. 200-W Nut Only	HF200-W	3.90
200-WC with Chain	HF200-WCH (with chain)	13.80

Larger Size Hose Fittings are available - price on application

Swivel Connector - Hose Barb to Female Hose		
HF195-06	3/8"	7.10
HF195-08	1/2"	5.60
HF195-10	5/8"	5.60
HF195-12	3/4"	6.00
HF195-16	1"	22.20
Coupling - Male Hose to Female Pipe		
HF197-08	1/2"	4.40
HF197-12	3/4"	5.85
Coupling - Female Hose to Male Pipe		
HF199-08	1/2"	7.75
HF199-12	3/4"	8.70
Swivel Coupling - Female Hose to Female Pipe		
HF199-08S	1/2"	8.55
HF199-12S	3/4"	9.25
Brass Hose Couplings Complete * (193 + 195)		
HF205-06	3/8"	16.50
HF205-08	1/2"	14.65
HF205-12	3/4"	15.00
HF205-16	1"	40.45
Rubber Hose Washers		
HF204-W	per hundred	31.80

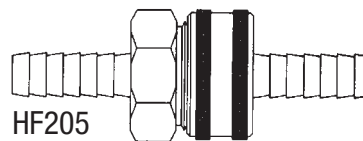
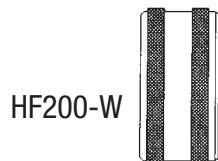
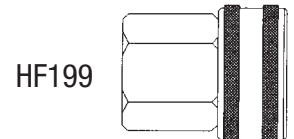
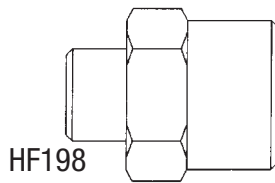
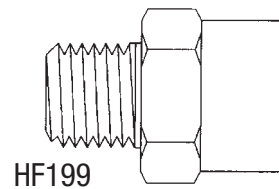
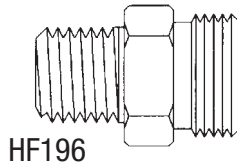
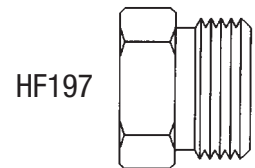
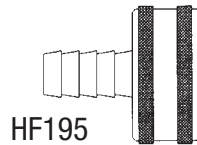
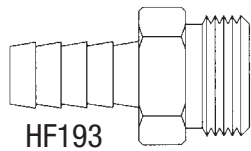

Brass Insert Fittings & Tank Tees

Male Insert Adapter		
HF125-12	3/4"	6.50
HF125-16	1"	11.25
HF125-20	1 1/4"	14.00
HF125-24	1 1/2"	18.15
HF125-32	2"	28.35
Male Reducing Adapter		
HF125-1216	3/4" MIP x 1 1/4" Insert	8.95
HF125-1620	1" MIP x 1 1/4" Insert	13.75
HF125-2016	1 1/4" MIP x 1" Insert	13.70
Male Long Shank Adapter		
HF125-16XL	1"	15.30
HF125-20XL	1 1/4"	21.00
HF125-2016XL	1 1/4" MIP x 1" Insert	20.05

Female Insert Adapter		
HF126-12	3/4"	8.50
HF126-16	1"	13.40
HF126-20	1 1/4"	16.05
HF126-24	1 1/2"	22.95
HF126-32	2"	33.90
Insert Coupling		
HF129-12	3/4"	6.67
HF129-16	1"	11.70
HF129-20	1 1/4"	16.35
HF129-24	1 1/2"	15.90
HF129-32	2"	23.85
Union Tank Tee		
HF2172-16	1" x 5 1/2"	34.00
HF2173-16	1" x 11"	P.O.A.

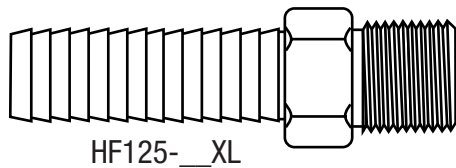
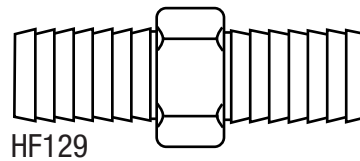
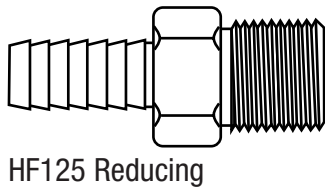
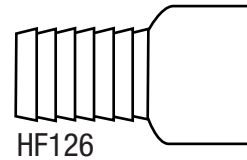
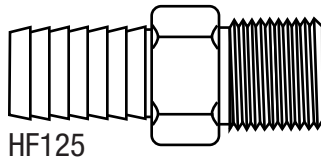

Brass insert Fittings & Tank Tees

Brass Tank Tee & Adapter		
HF2150-16	1"	19.75
HF2150-20	1 1/4"	27.80
Male Lug Adapter		
HF2070-16	1"	14.70
HF2070-20	1 1/4"	18.75
Brass Relief Valve		
HF2110-0808	1/2" MIP x 1/2" FIP	12.75
HF2110-1208	3/4" NIP x 1/2" FIP	12.35

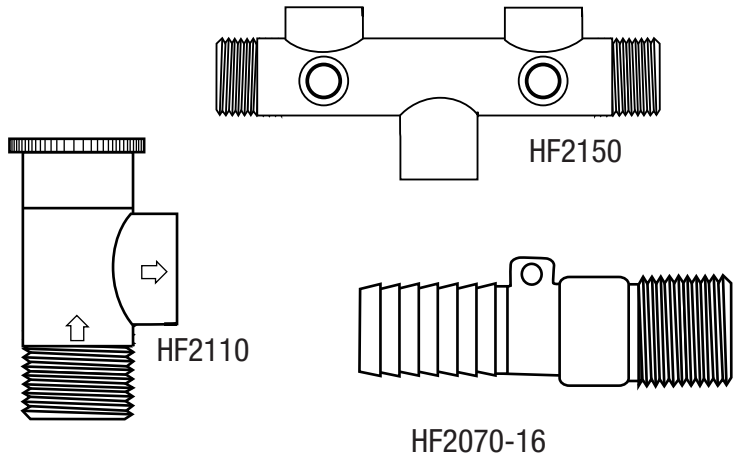

Also Available in Stainless Steel

BRYMER

INDUSTRIES INC.

80 Galaxy Blvd., Unit 8 & 9, Toronto, Ontario M9W 4Y8

Telephone: (416) 740-6222

Toll Free: 1-800-461-2769

Fax: (416) 740-4484

Website: www.brymerbrass.com

BRYMER SALES REPRESENTATIVES

BRITISH COLUMBIA

Brymer Industries Inc.
80 Galaxy Blvd., Unit 8 & 9,
Toronto, ON M9W 4Y8

Tel: 1-800-461-2769 Fax: (416) 740-4484

Bruce Brymer – bruceb@brymerbrass.com
info@brymerbrass.com

Wesmech Sales Inc.

11837 Woodlynn Court
N. Delta, B.C. V4E 3G6

Tel: (604) 596-9815 Fax: (604) 596-9148

Ken Wilson – wes.mech@telus.net

ALBERTA

Brymer Industries Inc.
80 Galaxy Blvd., Unit 8 & 9,
Toronto, ON M9W 4Y8

Tel: 1-800-461-2769 Fax: (416) 740-4484

Linda Porter – lindap@brymerbrass.com

SASKATCHEWAN

Westcan Mechanical
1555B McDonald St.

Tel: (306) 347-2700 Fax: (306) 359-3515

Blaine Campbell – westcanmechanical@sasktel.net

Connie Campbell – connie.westcan@sasktel.net

MANITOBA

Brymer Industries Inc.
80 Galaxy Blvd., Unit 8 & 9,
Toronto, ON M9W 4Y8

Tel: 1-800-461-2769 Fax: (416) 740-4484

Linda Porter – lindap@brymerbrass.com

NORTHERN ONTARIO

Laurentian Sales
346-2nd Ave. E.,

North Bay, ON P1B 1L6

Tel: (705) 476-1142 Fax: (705) 494-8068

Mike Guerin – michael093@sympatico.ca

SOUTH WESTERN ONTARIO

Mech - Tech Marketing
454 Commissioners Rd. E.,
London, ON N6C 2T7

Tel: (519) 680-3174 Fax: (519) 680-2055

Phil Lewis or *Greg Brand* –
phil@mechtech.ca or mail@mechtech.ca

ONTARIO

Brymer Industries Inc.
80 Galaxy Blvd., Unit 8 & 9,
Toronto, ON M9W 4Y8

Tel: 1-800-461-2769 Fax: (416) 740-4484

Bruce Brymer – bruceb@brymerbrass.com

Linda Porter – lindap@brymerbrass.com
info@brymerbrass.com

QUEBEC - (Montreal)

Dave Vallieres & Assoc. Inc.
81F Boul Brunswick,

Dollard Des Ormeaux, QC H9B 2J5

Tel: (514) 683-6844 Fax: (514) 685-4954

Dave Vallieres – dave@davevallieres.com

Pat Vallieres – pat@davevallieres.com

Michael Vallieres – mike@davevallieres.com

QUEBEC

Dave Vallieres & Assoc. Inc.

10 Rue, Romeo-Vezina, Quebec, QC G2B 4B8

Tel: (418) 842-0119 Fax: (418) 842-7416

Fernand Poirier – fernand@davevallieres.com

NOVAS SCOTIA & NEWFOUNDLAND

JBM Sales
1 Sunset Drive

River John (Marshville), NS B0K 1N0

Tel: (902) 351-2187 Fax: (902) 755-3485

Jamie Bergman – jbm-sales@ns.aliantzinc.ca

Tel: (902) 832-0480 Fax: (902) 832-4664

Kevin Guptell – jbm.guptell@ns.aliantzinc.ca

Robert Munn – munnrobert@eastlink.ca

Jim Barkhouse – jimbarkhouse@nx.aliantzinc.ca

NEW BRUNSWICK AND PRINCE EDWARD ISLAND

JBM Sales

Tel: (506) 855-1417 Fax: (506) 382-9721

Randy Parker – rjbm@nb.sympatico.ca

Alyre Gaudet – alyre.jbm@rogers.com